



# AMG2788RN-DR-CWDM6/8 Instruction Manual

## *Eight Channel Video Receive Unit with Eight Bi-directional Data and Audio Channels with Dual Redundant CWDM Operation on a dual fibre ring includes AMG NMS network Management Card*

**AMG2788R-DR-CWDM6/8** is a rackmount eight channel video receive unit designed to 'drop off' eight video signals from a dual optical fibre ring. It can also provide up to two low speed auxiliary low speed channels, Channel A and Channel B, for each video insert outstation. Channel A interface can either be a combined RS232, RS422 or RS485 common channel to each outstation or be individual data channels to each outstation with the physical layer protocol defined by data daughter boards on the data expansion boards. Channel B can provide individual data or audio channels each outstation with the physical layer defined at manufacture by the data daughter boards on the data expansion boards. The **AMG2788R-DR-CWDM6/8** is designed to plug into an **AMG2000** or an **AMG2005** subrack, which in turn fits into a 19" rack system. It also includes an AMG Network Management card to allow management of the system using the AMG SNMP enabled management software.

### Front panel Layout

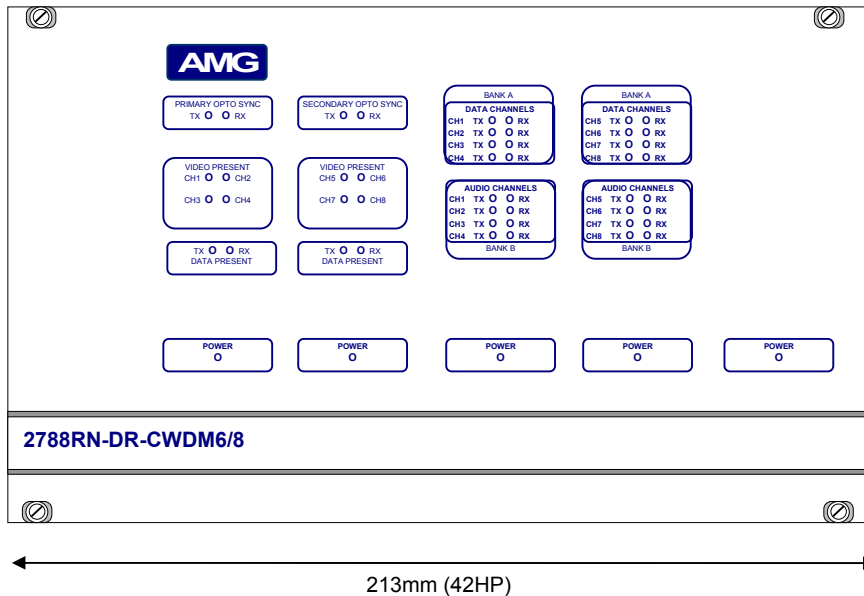

## Rear Panel Layout

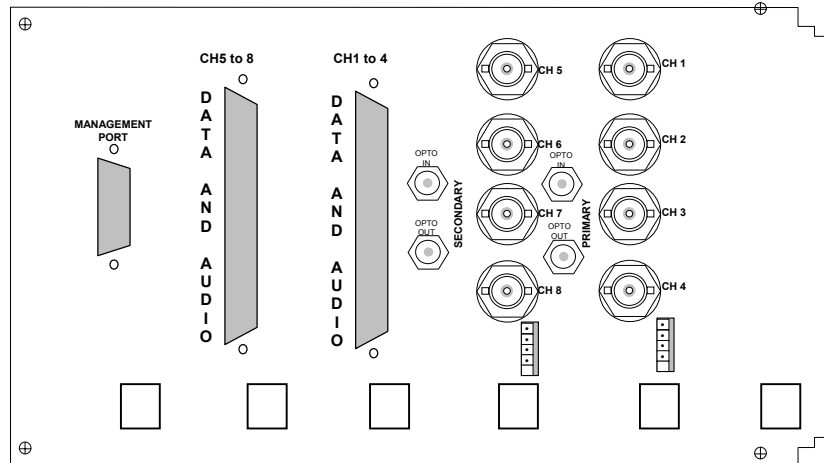

The **AMG2788RN-DR-CWDM6/8** is designed to operate with **AMG2783-1-DR-CWDM6/8**, **AMG2783-2-DR-CWDM6/8**, **AMG2783-4-DR-CWDM6/8** and **AMG2783-DR-CWDM6/8**, single channel, dual channel, 4 channel and 8 channel video and bi-directional data insert units respectively or their rackmount equivalents. Each receiver will 'drop off' up to eight video channels that are being transmitted around the single fibre ring. When used with an 8-channel transmitter the ring becomes a point to point system.

Where an addition data or audio channel is required for per video channel, the **AMG2788RN-DR-CWDM6/8** will operate with **AMG2787-1-DR-CWDM6/8**, **AMG2787-2-DR-CWDM6/8**, **AMG2787-4-DR-CWDM6/8** and **AMG2787-DR-CWDM6/8**, single channel, dual channel, 4 channel and 8 channel video and dual bi-directional data/audio insert units respectively or their rackmount equivalents.

Only one data and one data/audio channel is presented at each outstation unit regardless whether it is a 1, 2 or 4 channel insert unit.

Within the **AMG2788RN-DR-CWDM6/8**, fitting data and audio interface cards on to the data cards within the unit enables the data and audio interfaces. The unit accepts all AMG data interface types.

<b>Index</b>	<b>Page No.</b>
<b>Introduction</b> .....	<b>3</b>
Unit Functional Schematic .....	3
Optical System Connection .....	3
<b>Connections</b> .....	<b>6</b>
Video Output connections .....	6
Optical Connections .....	6
Power Connections .....	6
<b>Data and Audio Channel Configuration and Connection</b> .....	<b>6</b>
Individual Data Channels .....	6
<b>Data and Audio Channel Configuration</b> .....	<b>6</b>
<b>Data and Audio Daughter Board Fitting Instructions</b> .....	<b>7</b>
<b>Data and Audio Connections</b> .....	<b>8</b>
<b>Combined Data Channels</b> .....	<b>10</b>
<b>Configuration of Combined Data Channel</b> .....	<b>11</b>
<b>Indicators</b> .....	<b>12</b>
<b>Physical Information</b> .....	<b>14</b>
Dimensions.....	14
Mounting Details.....	14
<b>Removal from the Case</b> .....	<b>14</b>
<b>Safety</b> .....	<b>14</b>
<b>Maintenance and Repair</b> .....	<b>14</b>

## Introduction

### Unit Functional Schematic

The **AMG2788RN DR-CWDM6/8** receives optical signals from both a primary and secondary optical channels. These optical channels are transmitted on different optical fibres in different directions, operating at different wavelengths. The primary channel operates on 1490nm and the secondary channel on 1610nm.

The **AMG2788RN DR-CWDM6/8** drops off up to 8 video and up to 16 data and audio signals transmitted from **AMG2783-n-DR-CWDM6/8** or **AMG2787-n-DR-CWDM6/8** insert units and transmits out up to 16 data and audio channels back to the insert units.

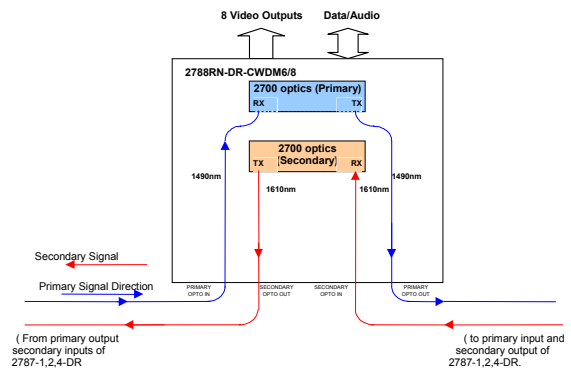

In normal operation, where connection of both the previous unit and the subsequent unit are OK, the video and data signal is taken from the primary input and the data transmitted out on the primary output. The secondary optical input is independent and is regenerated on to the secondary output.

If the primary input signal is not present, the unit will shut down the secondary output to inform the previous unit that the signal route is not OK. The previous unit will then send out the video and data signal on its secondary output in the opposite direction. This signal will be repeated around the ring to get back to this **AMG2788RN-DR-CWDM6/8** on the secondary route. As the primary input is not present on this unit, the video and data/audio signal will now be taken from the secondary optical input. Thus maintaining integrity of the video and data/audio transmission.

If the secondary input signal is not present, the unit will assume that the route to the next unit is not OK and send out the return data/audio signals on the secondary optical output. This return data/audio will be transmitted to the next unit around the ring in the opposite direction on the secondary route.

On recovery of a break the system automatically reverts back to normal operation.

### Optical System Connection

The **AMG2788RN-DR-CWDM6/8** units are designed to be connected in a ring or point to point system. In a ring system **AMG2783-1-DR-CWDM6/8**, **AMG2783-2-DR-CWDM6/8** and **AMG2783-4-DR-CWDM6/8**, single, dual and four channel insert units respectively can be combined to make up an 8 channel video transmission system as illustrated below. As each unit regenerates the optical signal, the optical dynamic range between each optically connected node is 22dB.

The operation is the same as when used with **AMG2787-1-DR-CWDM6/8**, **AMG2787-2-DR-CWDM6/8** and **AMG2787-4-DR-CWDM6/8**, single, dual and four channel insert units

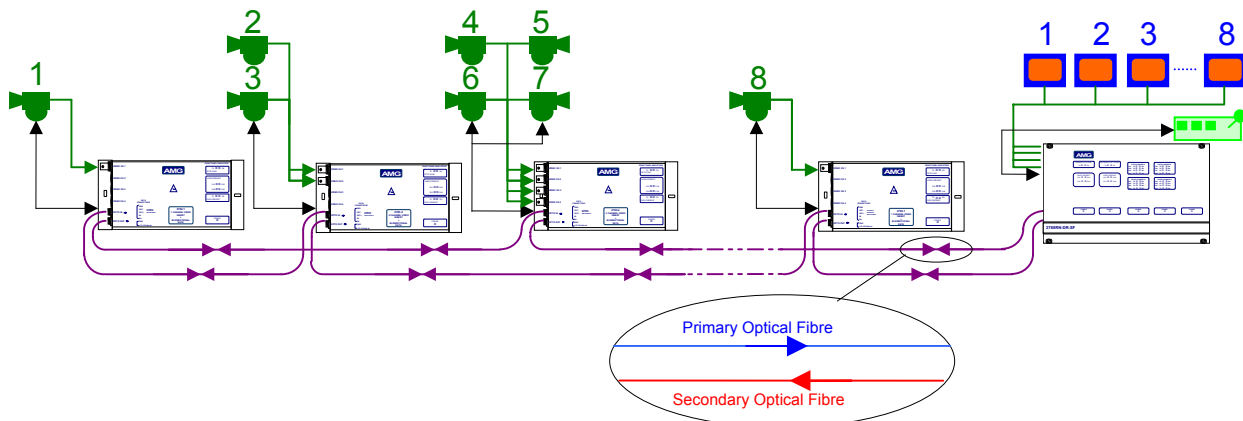

If a fibre link is broken, operation of the ring continues by making use of the secondary optical fibre route as below:

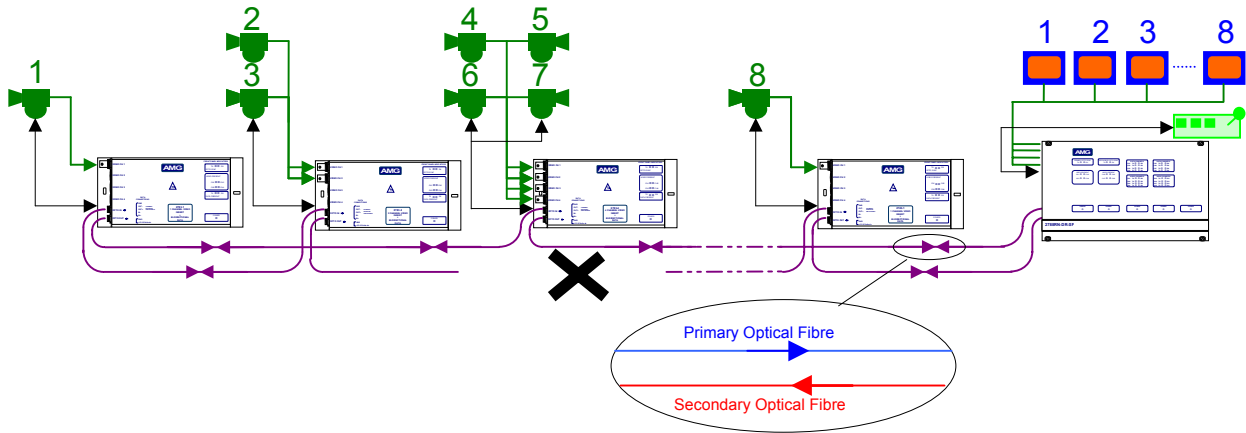

If multiple breaks occur, operation is maintained with all the units still physically connected to the receiver. For the scenario shown below camera signals and control would now be lost from cameras 1,2 and 3, as there is now no physical connection between the transceivers and the receiver. However operation of cameras 4,5,6,7 and 8 remains fully functional.

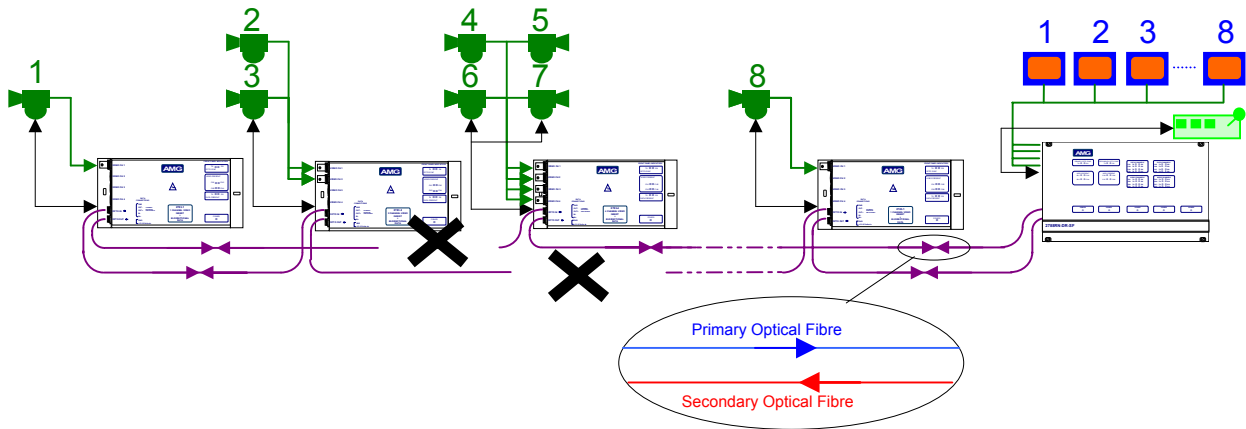

Note that where necessary repeaters can be added at nodes to increase the distance between nodes.

The **AMG2788RN-DR-CWDM6/8** is connected as illustrated below when used with an **AMG2783R-DR-CWDM6/8** 8-channel insert unit acting as a point to point system.

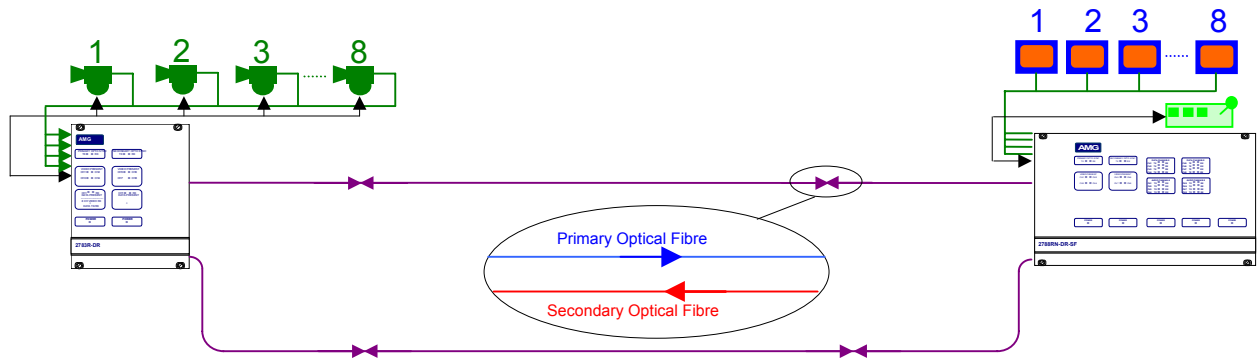

Again if one of the routes is broken, operation of the system is maintained as shown below:

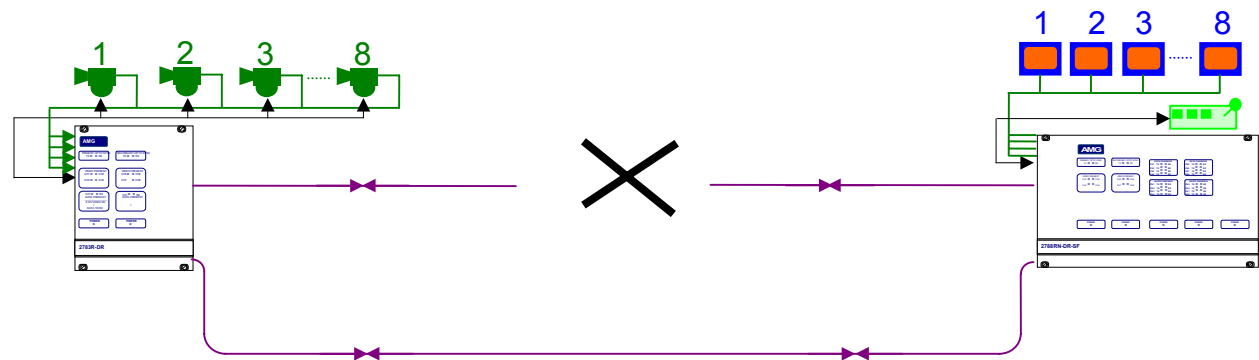

Or:

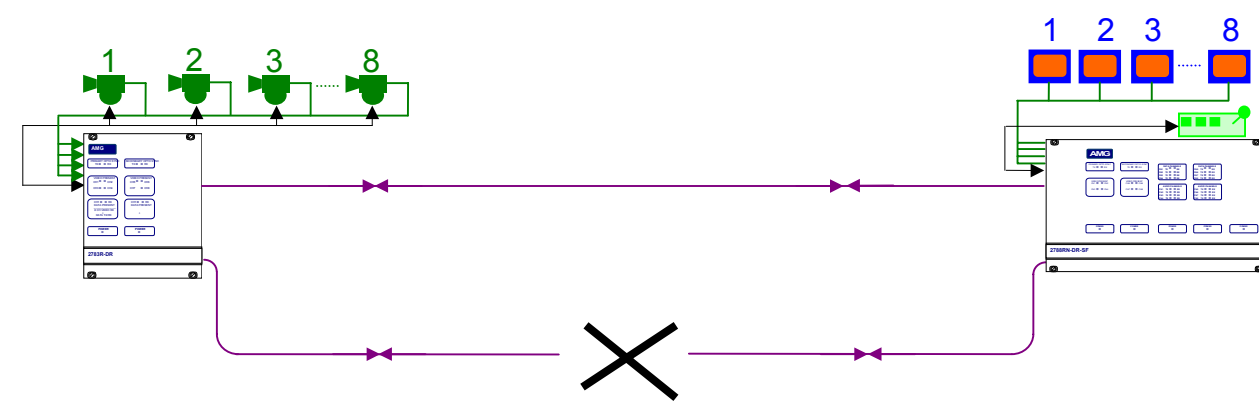

## Connections

### Video Output Connections

Connector ..... 75 ohm BNC Socket.  
Output Impedance ..... 75 ohm terminated.  
Output Level ..... 1 volt p-p nominal  
Frequency Response ..... 10Hz to 5.75MHz min.  
No of channels..... 8

### Optical Connections

#### PRIMARY OPTO OUT

Connector ..... FC/PC  
Primary Optical Launch Power ..... 0dBm  
Wavelength..... 1490nm

Secondary Optical Sensitivity ..... -22dBm  
Wavelength..... 1310nm to 1610nm

#### PRIMARY OPTO IN

Connector ..... FC/PC  
Primary Optical Sensitivity ..... -22dBm  
Wavelength..... 1310nm to 1610nm

Secondary Optical Launch Power ..... 0dBm  
Wavelength..... 1610nm

### Power Connection

Power supply ..... from plug in connection on the 2000 or 2005 subrack  
Power consumption ..... 30 Watts max.

## Data and Audio Channel Configuration and Connection

The **AMG2788RN-DR-CWDM6/8** sends and receives data in two banks, Bank A and Bank B. Bank A data can be combined, which means a single combined data channel to all outstations, or individual, which means one channel to each outstation. Bank B data is always individual and can be data or audio determined by the fitting of data daughter boards onto the data expansion motherboards.

### Individual Data Channels

No of Data Channels ..... 8  
No of Secondary  
Data/Audio Channels..... 8  
Connector ..... On two 37-way D-Type female connectors - shielded.  
Connections..... See below for connection and configuration

When individual channels selected the **AMG2788RN-DR-CWDM6/8** has a capacity for 8 bi-directional data and 8 bi-directional data or audio channels. For these channels to be present, appropriate data daughter boards have to be fitted onto the main data motherboards.

The two data motherboards correspond data channels 1-4 and channels 1-8 respectively.

### Data and Audio Channel Configuration

The data and audio daughter boards slots are accessed by removing the 2700 unit from the case. (See below for **removal from the case**).

In order to enable a data channel an appropriate daughter board should be fitted in the upper data channel slots on the main data motherboard. Each data interface board enables one bi-directional channel. The data interface daughter board options are as follows:

Option Code	Part No.	Description
1	X04057	RS422/485 Data Interface Daughter Board
2	X04049	RS232 Data Interface Daughter Board
3	X04058	20mA Current Loop Data Interface Daughter Board
4	X04059	TTL Data Interface Daughter Board
5	X12578	Contact Closure Data Interface Daughter Board
6	X13038	FTT10A Echelon Lonworks Data Interface Daughter Board

In order to enable an audio channel an appropriate daughter board should be fitted in the lower audio channel slots on the main data motherboard. Each audio interface board enables one bi-directional channel. The audio interface daughter board part number is as follows:

Option Code	Part No.	Description
0	X14542	4 Wire Audio Interface Daughter Board

The channel slots are as follows:

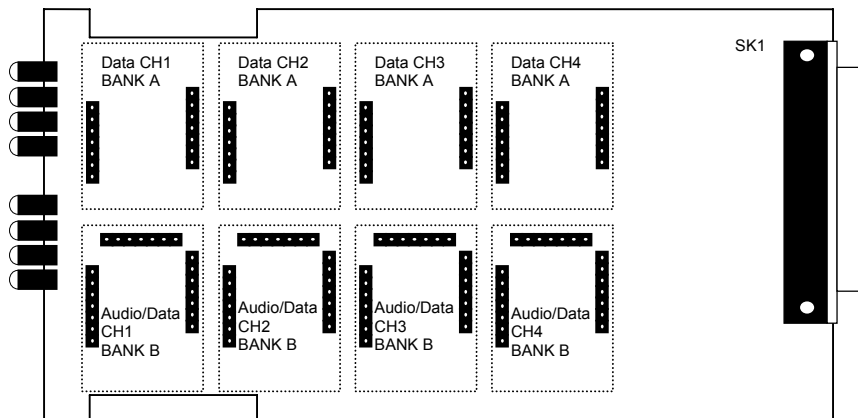

### ***Data and Audio Daughter Board Fitting Instruction***

The data and audio daughter boards pushed on to the pin headers mounted on the main data motherboard. Ensure that the connectors are lined up correctly and not offset before pushing firmly in place. Note that the data and audio channel numbers are associated with each slot. This allocates the pin numbers on the rear panel.

## Data and Audio Connections

The BANK A and BANK B data/audio channels 1- 4 pin numbers are as follows:

Pin No.	Description	Bank
1	DATA CH1 IN +	A
2	DATA CH1 IN -	A
3	DATA CH2 IN +	A
4	DATA CH2 IN -	A
5	DATA CH3 IN +	A
6	DATA CH3 IN -	A
7	DATA CH4 IN +	A
8	DATA CH4 IN -	A
9	GND	
10	GND	
11	GND	
12	AUDIO/DATA CH1 IN +	B
13	AUDIO/DATA CH1 IN -	B
14	AUDIO/DATA CH2 IN +	B
15	AUDIO/DATA CH2 IN -	B
16	AUDIO/DATA CH3 IN +	B
17	AUDIO/DATA CH3 IN -	B
18	AUDIO/DATA CH4 IN +	B
19	AUDIO/DATA CH4 IN -	B

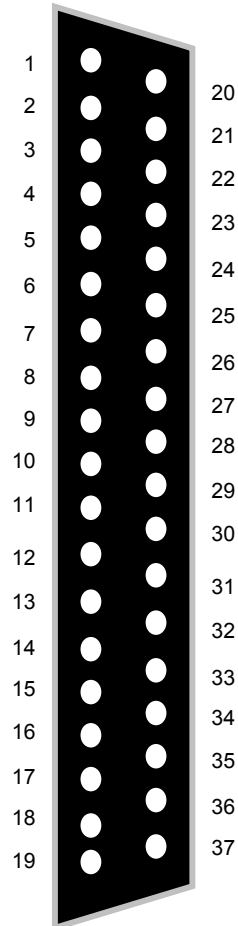

Pin No.	Description	Bank
20	DATA CH1 OUT +	A
21	DATA CH1 OUT -	A
22	DATA CH2 OUT +	A
23	DATA CH2 OUT -	A
24	DATA CH3 OUT +	A
25	DATA CH3 OUT -	A
26	DATA CH4 OUT +	A
27	DATA CH4 OUT -	A
28	GND	
29	GND	
30	AUDIO/DATA CH1 OUT +	B
31	AUDIO/DATA CH1 OUT -	B
32	AUDIO/DATA CH2 OUT +	B
33	AUDIO/DATA CH2 OUT -	B
34	AUDIO/DATA CH3 OUT +	B
35	AUDIO/DATA CH3 OUT -	B
36	AUDIO/DATA CH4 OUT +	B
37	AUDIO/DATA CH4 OUT -	B



The data and audio channels 5-8 pin numbers are as follows:

Pin No.	Description	Bank
1	DATA CH5 IN +	A
2	DATA CH5 IN -	A
3	DATA CH6 IN +	A
4	DATA CH6 IN -	A
5	DATA CH7 IN +	A
6	DATA CH7 IN -	A
7	DATA CH8 IN +	A
8	DATA CH8 IN -	A
9	GND	
10	GND	
11	GND	
12	AUDIO/DATA CH5 IN +	B
13	AUDIO/DATA CH5 IN -	B
14	AUDIO/DATA CH6 IN +	B
15	AUDIO/DATA CH6 IN -	B
16	AUDIO/DATA CH7 IN +	B
17	AUDIO/DATA CH7 IN -	B
18	AUDIO/DATA CH8 IN +	B
19	AUDIO/DATA CH8 IN -	B

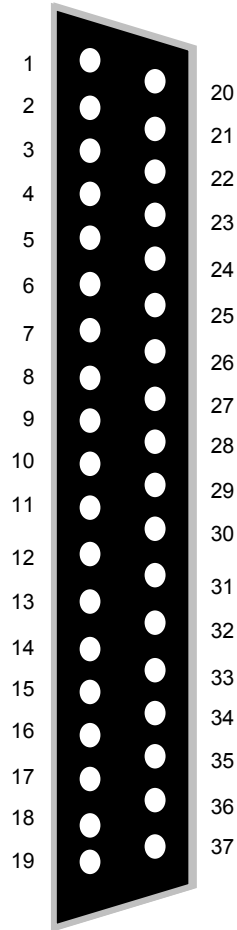

Pin No.	Description	Bank
20	DATA CH5 OUT +	A
21	DATA CH5 OUT -	A
22	DATA CH6 OUT +	A
23	DATA CH6 OUT -	A
24	DATA CH7 OUT +	A
25	DATA CH7 OUT -	A
26	DATA CH8 OUT +	A
27	DATA CH8 OUT -	A
28	GND	
29	GND	
30	AUDIO/DATA CH5 OUT +	B
31	AUDIO/DATA CH5 OUT -	B
32	AUDIO/DATA CH6 OUT +	B
33	AUDIO/DATA CH6 OUT -	B
34	AUDIO/DATA CH7 OUT +	B
35	AUDIO/DATA CH7 OUT -	B
36	AUDIO/DATA CH8 OUT +	B
37	AUDIO/DATA CH8 OUT -	B

See Data or Audio Daughter Board Instruction Sheet for specific data type connections

**Combined Data Channels  
BANK A ONLY**

Number of Channels..... Two independent data channels, one associated with video channels 1-4 and another associated with video channels 5-8. These will be normally combined when a NMS Management Card is fitted.

Data Connector ..... 5 way removable spring terminal connector (2.5mm spacing)  
Manufacturers Part No. Phoenix/Combicom FK-MC-0.5/5-ST-2.5  
AMG Part No G15098-00

SW1 used to select between RS232 and RS485/422, SW2 is used to select between RS422 and RS485.

**NOTE: The unit is shipped from the factory as RS422 unless otherwise requested.**

Connections RS422 4 wire..... See schematic

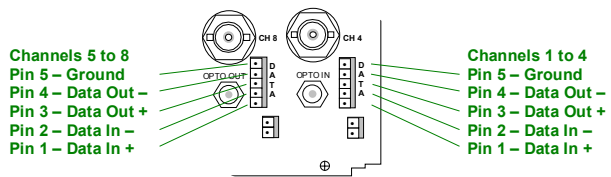

Connections RS485 4 wire..... See schematic

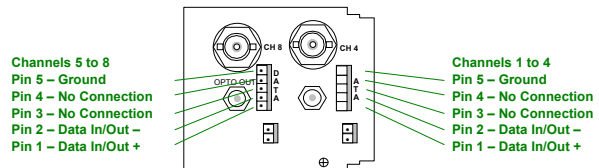

Connections RS232..... See schematic

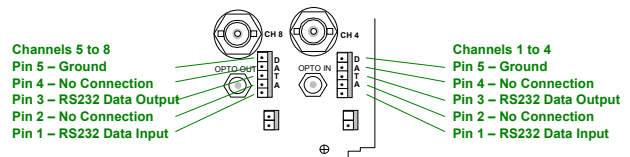

Protocol.....RS232  
 SW1 switch position 9 on, switch position 10 on  
 SW2 all off

RS485 2wire  
 SW1 switch position 9 off, switch position 10 off  
 SW2 see below

RS422 4 wire Bus'ed or point to point  
 SW1 switch position 9 off, switch position 10 off  
 SW2 see below

See below for **Configuration of the RS485 / RS422 data channel** and description of tristate operation  
 Each of the two data channels can be set up independently.

**Configuration of the Combined Data Channel**

SW1 and SW2 determine the protocol of the data channel. This can be either RS232, RS485 or RS422.  
 (See below for **removal from the case** and access to SW1 and SW2)

**Mode 1 – RS485 two wire half duplex transmission.**

**Mode 2 – RS422 four wire full duplex transmission.**

In this mode the RS422 output will transmit a tristate condition as well as a logic high and a logic low for systems which require bus-ing of the RS422 four-wire connection.

MODE	Configuration Details	SW2 position 1	SW2 position 2	SW2 position 3	SW2 position 4	SW1 position 9	SW1 position 10
1	RS-422 4 wire Point-to-Point - and RS-422 BUS system	OFF	OFF	OFF	OFF	OFF	OFF
2	RS-485 2 wire BUS systems	OFF	ON	ON	ON	OFF	OFF

The data input for both the RS485 and the RS422 modes detects a tri-state input condition by monitoring the differential voltage level across the input. A differential level below 500mV positive or negative will be detected as a tristate condition. A level above 500mV positive or negative will be detected as a logic 1 or logic zero respectively. **It is important therefore to terminate the RS485 bus or the RS422 input bus using 120ohms if a pre-bias is present on the RS485 or RS422 bus.** A large number of third party equipment manufacturers apply a pre-bias on their RS485 bus. This pre-bias is applied by pulling one arm of the RS485 bus high (+5 volts) and the other arm low (0 volts) using high value resistors within the third party equipment. In order to ensure that the AMG2700 equipment detects a tri-state condition, then these resistors should have a value above 1kohm.

**Mode 3 – RS232 full duplex transmission.**

MODE	Configuration Details	SW2 position 1	SW2 position 2	SW2 position 3	SW2 position 4	SW1 position 9	SW1 position 10
3	RS-232 Point to Point	OFF	OFF	OFF	OFF	ON	ON

**Note: - the data channel is set at Mode 1 – RS485 operation at the factory unless otherwise requested.**

## SW1 Switch Settings

All SW1 switch settings are set at the factory as follows:

Channels 1-4 Card

Switch Position	Description	Setting
1	Video channel configuration	OFF
2	Video channel configuration	OFF
3	Video channel configuration	OFF
4	Primary / Secondary Board Setting	ON
5	Dual Redundant / Not dual redundant	OFF
6	Master	ON
7	Full Scale Calibration Output	OFF
8	On board data / Separate data card	ON
9	RS232 Select	OFF for RS485/422
10	RS232 Select	OFF for RS485/422

Channels 5-8 Card

Switch Position	Description	Setting
1	Video channel configuration	OFF
2	Video channel configuration	OFF
3	Video channel configuration	ON
4	Primary / Secondary Board Setting	OFF
5	Dual Redundant / Not dual redundant	OFF
6	Master	ON
7	Full Scale Calibration Output	OFF
8	On board data / Separate data card	ON
9	RS232 or RS422/485	OFF for RS485/422
10	RS232 or RS422/485	OFF for RS485/422

## Indicators

Power..... Green – unit powered  
Off – no power applied to unit

Primary Opto Sync TX..... Green - optical channel transmitting  
Off - optical channel not transmitting

Primary Opto Sync RX .....	Green	- optical channel receiving
	Off	- optical channel not receiving
Secondary Opto Sync TX .....	Green	- optical channel transmitting
	Off	- optical channel not transmitting
Secondary Opto Sync RX.....	Green	- optical channel receiving
	Off	- optical channel not receiving
Video Present CH1-8.....	Green	- video signal present on video output BNC
	Red/Green	- Channel present , no video
	Red	- Fibre Loop Present, no TX selected on this channel
	Off	- no Fibre Loop Present thus no video present on video channel input BNC

**(When on board, combined data is selected)**

Data Present TX .....	Green	- logic one present on the data input
	Red	- logic zero present on the data input
	Off	- tri-state off or no connection on the data input

This represents the data signals being transmitted on the optical fibre

Data Present RX.....	Green	- logic one present on the corresponding data output
	Red	- logic zero present on the data output
	Off	- tri-state off on the data output

This represents the data signals being received on the optical fibre

**(When data slot contains a data daughter board)**

Data Present CH1-8 TX.....	Green	- logic one present on the data input
	Red	- logic zero present on the data input
	Off	- tri-state off or no connection on the data input

This represents the data signals being transmitted on the optical fibre

Data Present CH1-8 RX .....	Green	- logic one present on the corresponding data output
	Red	- logic zero present on the data output
	Off	- tri-state off on the data output

This represents the data signals being received on the optical fibre

**(When audio slot contains an audio daughter board)**

Audio Present TX .....	Green	- when an audio level between -40dBm and +0dBm is on the audio input (600ohm).
.....	Red	- when an audio level above 0dBm is on the audio input. (600ohm).
.....	Red/Green	- when an audio level peaking above 0dBm is on the audio input. (Note audio daughter board will accept up to +6dBm(600ohm)).
.....	Off	- when an audio level is below -40dBm on the audio input. (600ohm).

This represents the audio signals being transmitted on the optical fibre

Audio Present RX .....	Green	- when an audio level between -40dBm and +0dBm is on the audio output (600ohm).
.....	Red	- when an audio level above 0dBm is on the audio output. (600ohm).
.....	Red/Green	- when an audio level peaking above 0dBm is on the audio output. (Note audio daughter board will transmit up to +6dBm(600ohm)).
.....	Off	- when an audio level is below -40dBm on the audio output. (600ohm).

This represents the audio signals being received from the optical fibre

## The Management Card

The AMG2700 Management card is fitted within AMG2782RN, AMG2784RN and AMG2788RN receivers and is signified by a 'N' in the part number

Each management card, thus each receiver, has a ID number with is identified below the management port. This ID number is used by the AMG Network Management System (NMS) to identify the unit.

The physical interface is a 9 way female D-type connector.

### Management Port Pinout

Pin Number	RS232 Connection	RS485 Connection
1	-	Data +
2	RD (data out of port)	-
3	TD (data into port)	-
4	-	Data -
5	SG (signal ground)	SG (signals Ground)
6	N/C	N/C
7	N/C	N/C
8	N/C	N/C
9	N/C	N/C

**For multiple Management Ports it is recommended that the RS485 interface is used with each RS485 pair connected in parallel. In this case a RS485 to RS232 converter is required in order to connect to a normal PC Comm Port.**

**The time delay between receiving a data request and sending out a response from the port is 625us. Therefore any RS232 or RS485 converter should have a 'turn around' time or 'transmit dwell' time equal to or less than 625us.**

## Physical Information

### Dimensions

Height .....3U Plug-in  
Width.....42HP  
Depth .....170mm excluding connectors  
Weight.....1500grams

### Mounting Details

The unit is designed to be mounted within a 2000 or 2005 Subrack on standard card guides. Note the AMG standard racks are supplied with guide rails every 7HP. In order to fit this unit in the subrack, 6 sets of card guides have to be removed by pulling gently on the card guides.

The 2000 series subrack is fitted with a 50 watt power supply.

The 2005 series subrack is fitted with a 100 watt power supply.

### Removal from the Case

**Note:** - The 2700 PCB's are static sensitive. Handle with proper care and use normal electrostatic discharge (ESD) procedures. Use properly grounded protection (for example, wrist straps) when handling the PCB. The switch positions can be accessed without removing the PCB's from the case. To do this the six screws fixing the top panel to the side panels can be removed and the top panel lifted out of the way.

## **Safety**

The 2700 series of products uses a Class 1 laser system in accordance with EN 60825-2:2000.

It is always advisable to follow good practice when working with optical fibre systems. This includes:

- Do not stare with unprotected eyes or with any unapproved collimating device at fibre ends or connector faces, or point them at other people.
- Use only approved filtered or attenuating viewing aids

For other safety issues and advice on good practice associated with the optical fibres systems see EN 60825-2:2000 or your local safety officer.

## **Maintenance and Repair**

There are no user serviceable parts within the AMG2700 products.

In case of problem or failure contact your local support centre or AMG Systems Ltd, Technical Support Department on tel. +44 (0) 1767 600777.

See unit data sheet for full specification.